

# TOILET REPAIR PARTS • FLAPPERS & BALLS | KOHLER

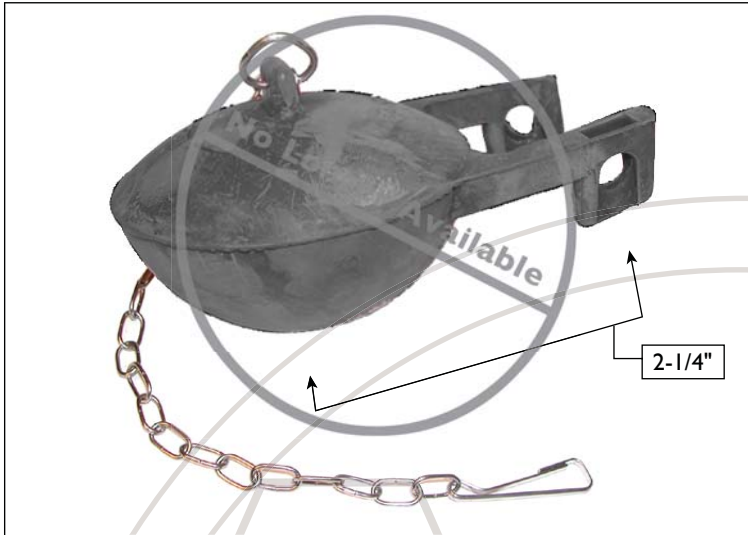

**KOH42388 • FLAPPER**

NLA USE KOHGP49114

CHAIN: LINK W/CLIP • CHAIN LENGTH: 8"

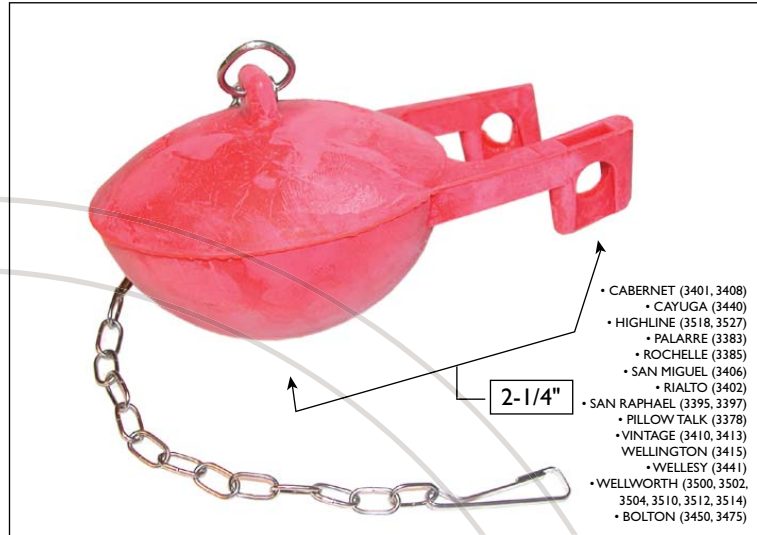

**KOH49114 • FLAPPER**

CHAIN: LINK W/CLIP • CHAIN LENGTH: 8"

- CABERNET (3401, 3408)
- CAYUGA (3440)
- HIGHLINE (3518, 3527)
- PALARRE (3383)
- ROCHELLE (3385)
- SAN MIGUEL (3406)
- RIALTO (3402)
- SAN RAPHAEL (3395, 3397)
- PILLOW TALK (3378)
- VINTAGE (3410, 3413)
- WELLINGTON (3415)
- WELLESY (3441)
- WELLWORTH (3500, 3502, 3504, 3510, 3512, 3514)
- BOLTON (3450, 3475)



**KOH51200 • BALL**

NLA USE KOHGP88921

OLD STYLE BALL

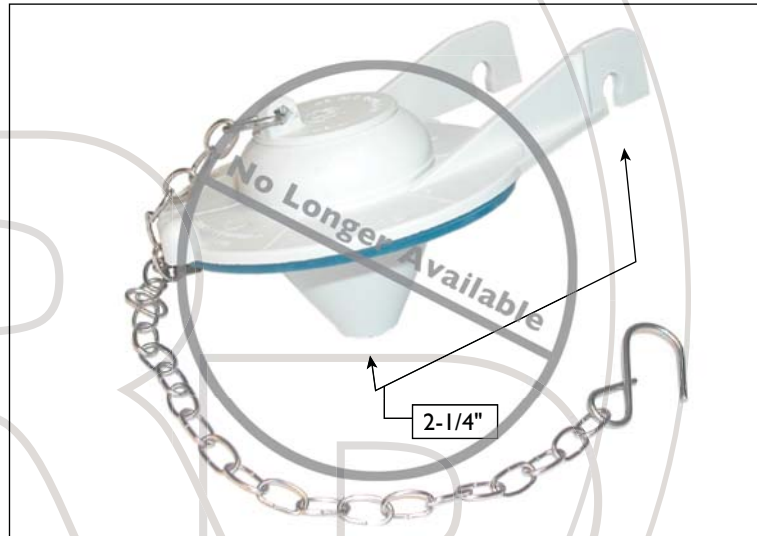

**KOH55477 • FLAPPER**

NLA USE KOHGPI079948

CHAIN: LINK W/J-CLIP • CHAIN LENGTH: 11-1/2" • HARD

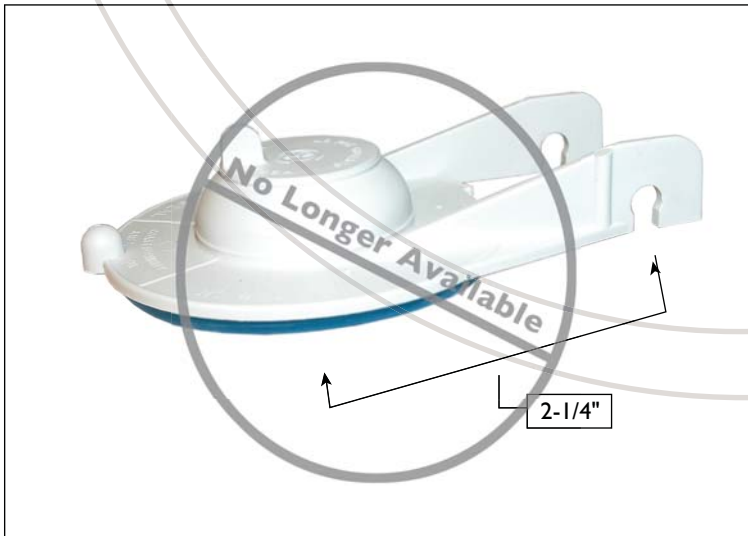

**KOH81096 • FLAPPER**

NLA USE KOHGPI079948

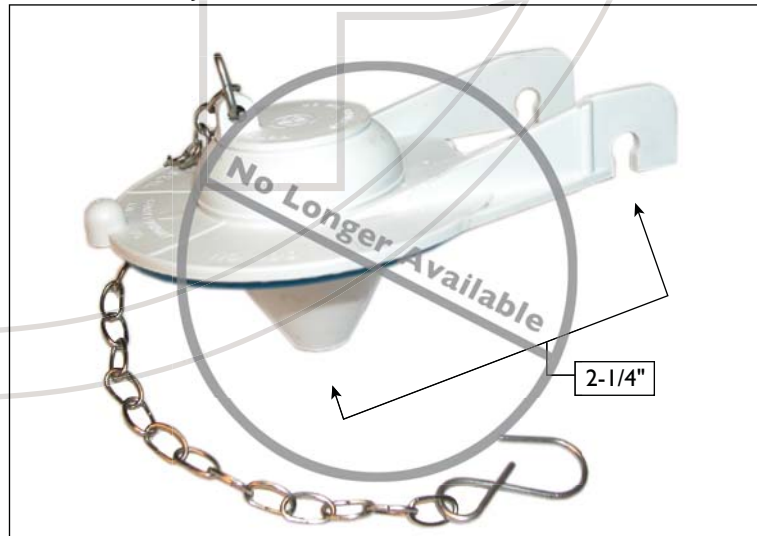

**KOH83948 • FLAPPER**

NLA USE KOHGPI079949

# TOILET REPAIR PARTS • FLAPPERS & BALLS | KOHLER

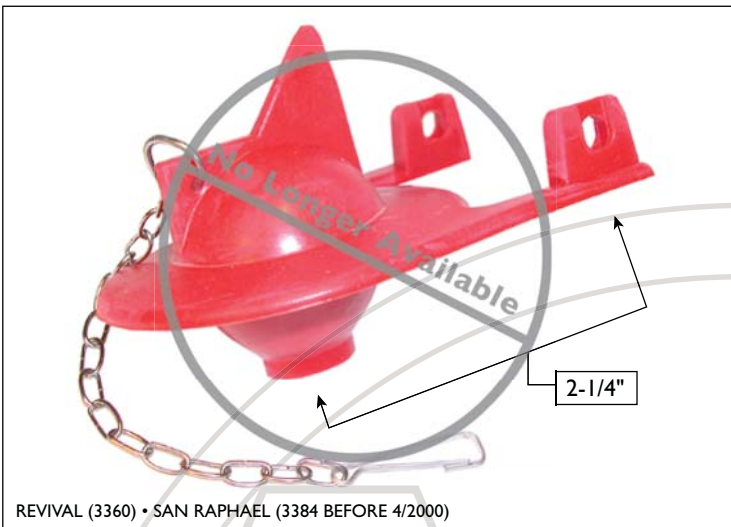

REVIVAL (3360) • SAN RAPHAEL (3384 BEFORE 4/2000)

**KOH84138 • FLAPPER**  
 NLA USE KOHGPI078440  
 CHAIN: LINK W/CLIP • CHAIN LENGTH: 4"

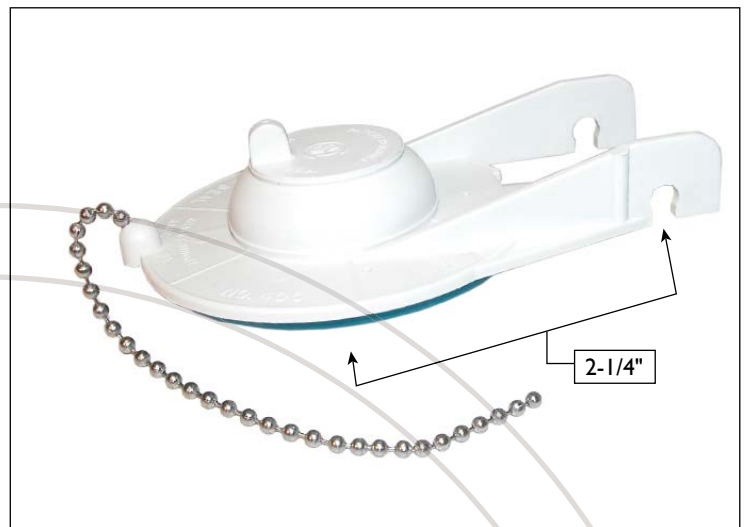

**KOH84143 • FLAPPER**  
 CHAIN: BEADED • CHAIN LENGTH: 5" • HARD

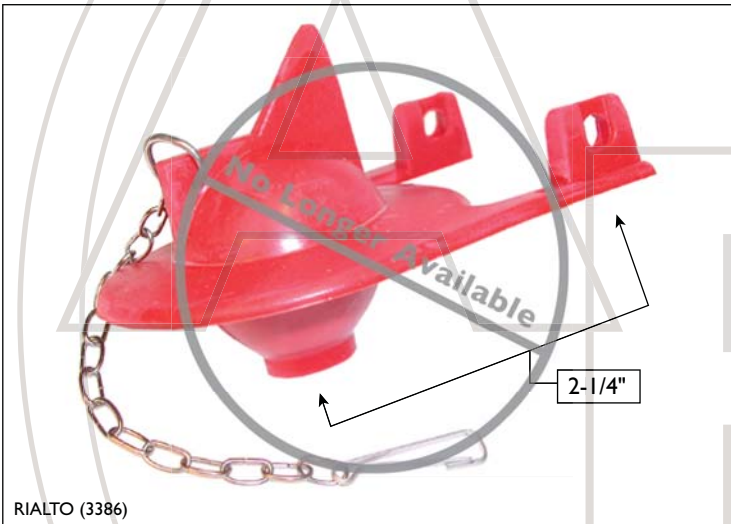

RIALTO (3386)

**KOH84314 • FLAPPER**  
 NLA USE KOHGPI078440  
 CHAIN: LINK W/CLIP • CHAIN LENGTH: 4"

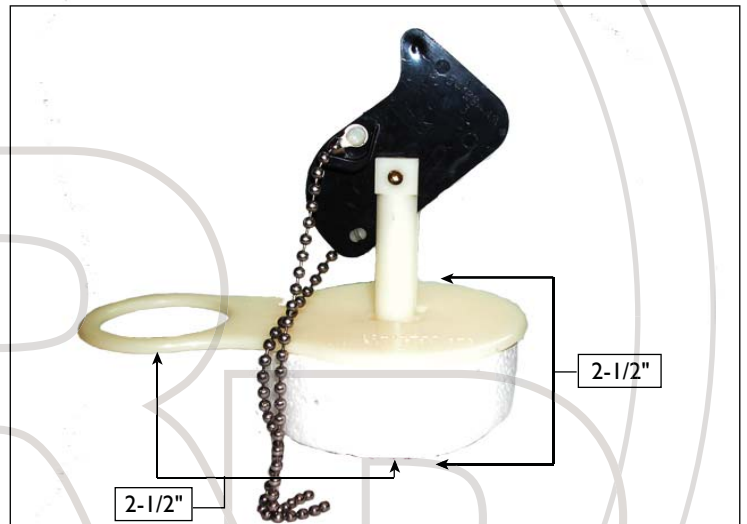

**KOH84355 • DUAL FLUSH KIT**  
 CHAIN: BEADED • CHAIN LENGTH: 5"

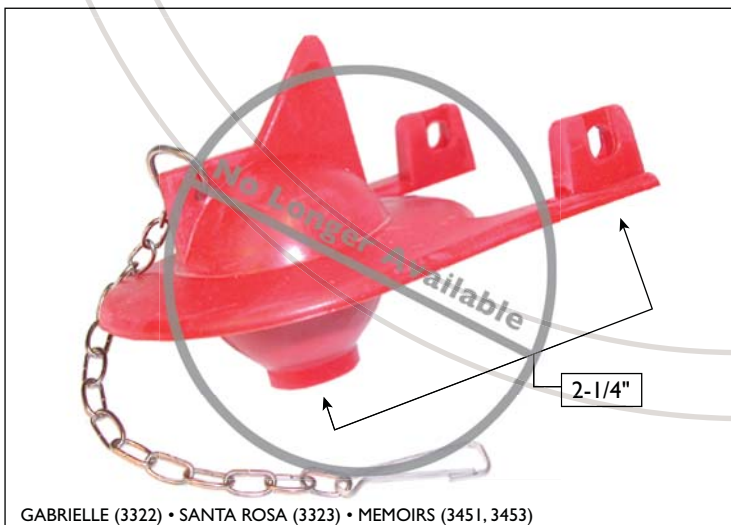

GABRIELLE (3322) • SANTA ROSA (3323) • MEMOIRS (3451, 3453)

**KOH85655 • FLAPPER**  
 NLA USE KOHGPI078440  
 CHAIN: LINK W/CLIP • CHAIN LENGTH: 5"

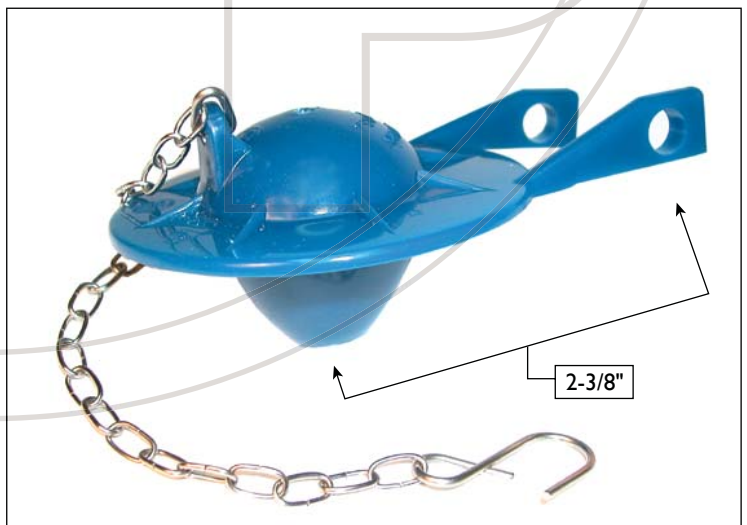

**KOH87449 • FLAPPER**  
 CHAIN: LINK W/J-CLIP • CHAIN LENGTH: 8"

# TOILET REPAIR PARTS • FLAPPERS & BALLS | KOHLER

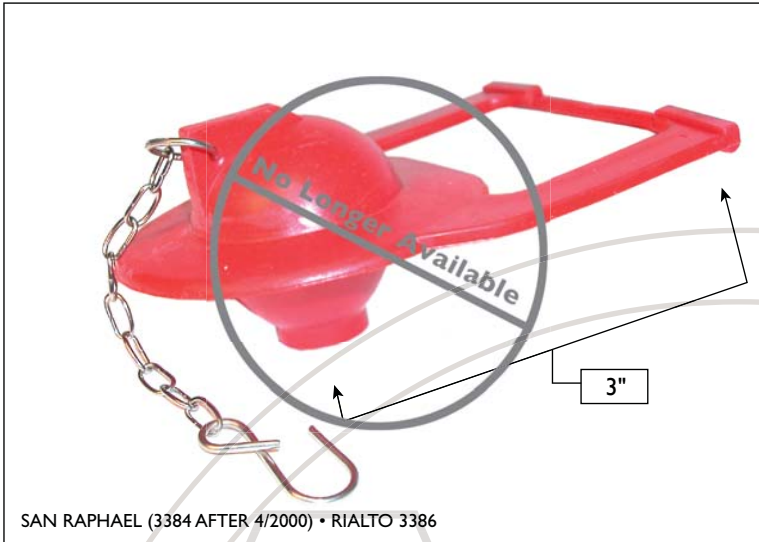

SAN RAPHAEL (3384 AFTER 4/2000) • RIALTO 3386

**KOH1000490 • FLAPPER**  
 NLA USE KOHGP84995  
 CHAIN: LINK W/J-CLIP • CHAIN LENGTH: 3"

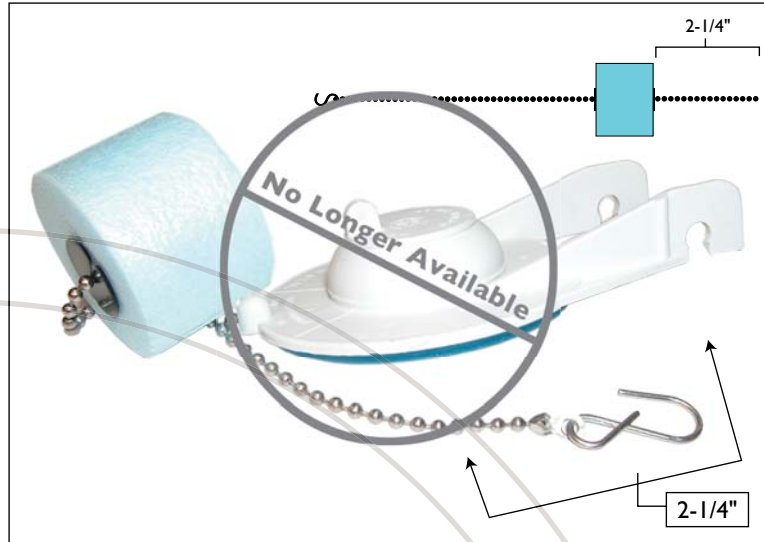

**KOH1006958 • FLAPPER**  
 NLA USE KOHGP1079948  
 CHAIN: BEADED W/J-CLIP • CHAIN LENGTH: 11" • FLOAT • HARD



**KOH1010375 • FLAPPER**  
 CHAIN: PLASTIC LINK W/CLIP • CHAIN LENGTH: 3-1/2"

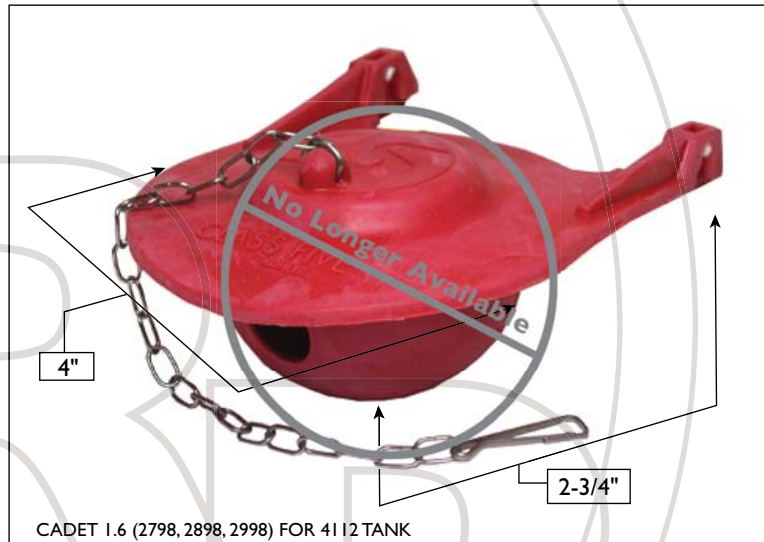

CADET 1.6 (2798, 2898, 2998) FOR 4112 TANK

**KOH1016546 • FLAPPER**  
 NLA USE KOHGP1078441  
 CHAIN: LINK W/CLIP • CHAIN LENGTH: 7-1/2" O

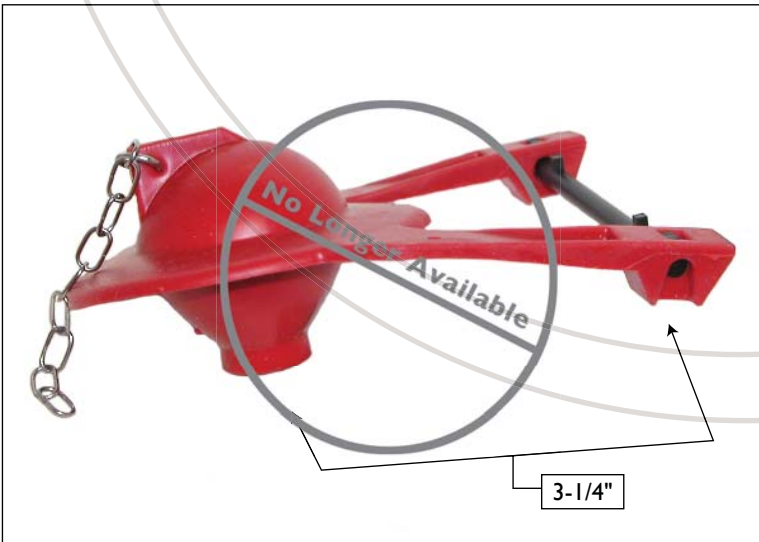

**KOH1078577 • FLAPPER**  
 NLA USE KOHGP84995  
 CHAIN: LINK • CHAIN LENGTH: 3"

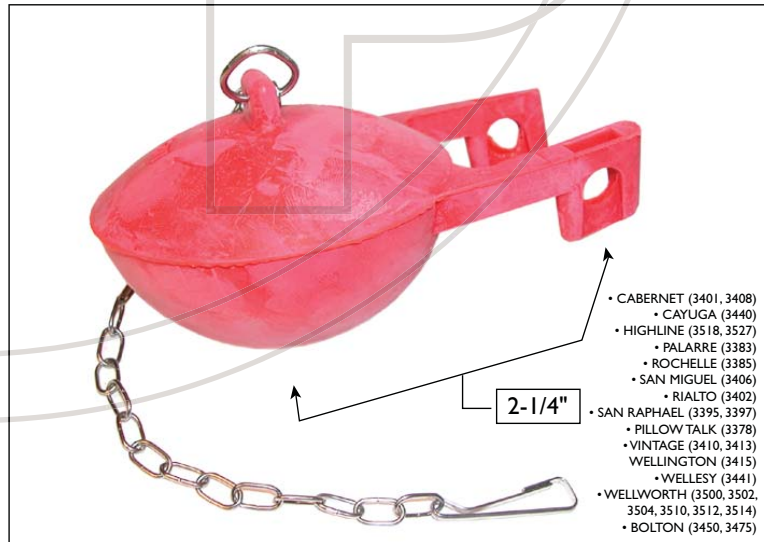

**KOHGP49114 • FLAPPER**  
 CHAIN: LINK W/CLIP • CHAIN LENGTH: 8"

- CABERNET (3401, 3408)
- CAYUGA (3440)
- HIGHLINE (3518, 3527)
- PALARRE (3383)
- ROCHELLE (3385)
- SAN MIGUEL (3406)
- RIALTO (3402)
- SAN RAPHAEL (3395, 3397)
- PILLOW TALK (3378)
- VINTAGE (3410, 3413)
- WELLINGTON (3415)
- WELLESY (3441)
- WELLWORTH (3500, 3502, 3504, 3510, 3512, 3514)
- BOLTON (3450, 3475)

# TOILET REPAIR PARTS • FLAPPERS & BALLS | KOHLER

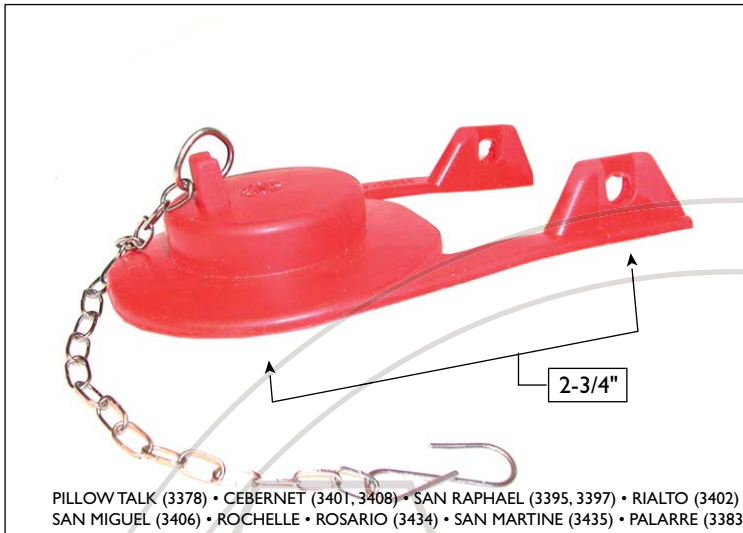

PILLOW TALK (3378) • CEBERNET (3401, 3408) • SAN RAPHAEL (3395, 3397) • RIALTO (3402)  
SAN MIGUEL (3406) • ROCHELLE • ROSARIO (3434) • SAN MARTINE (3435) • PALARRE (3383)

**KOHGP83064 • FLAPPER**  
CHAIN: LINK W/J-CLIP • CHAIN LENGTH: 9" • STYROFOAM

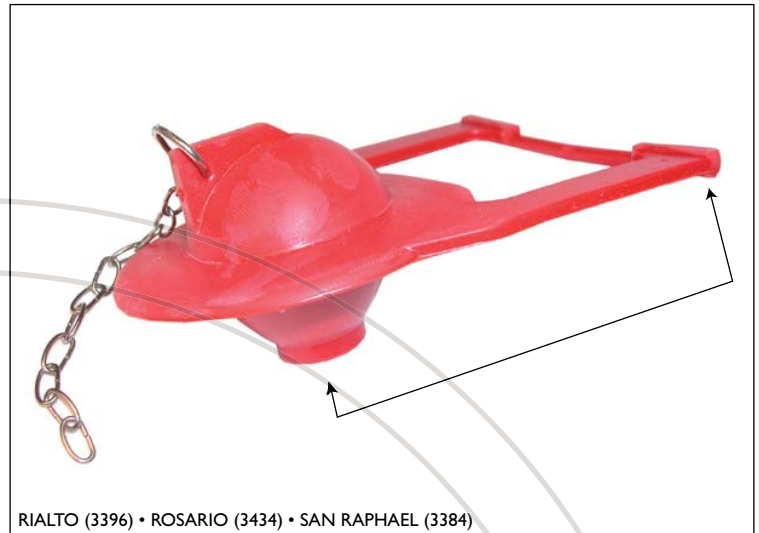

RIALTO (3396) • ROSARIO (3434) • SAN RAPHAEL (3384)

**KOHGP84995 • FLAPPER**  
CHAIN: LINK • CHAIN LENGTH: 4"

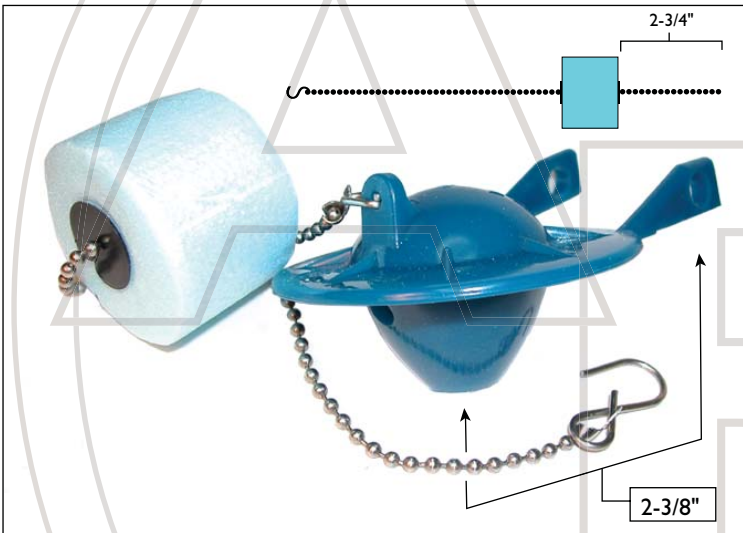

**KOHGP85160 • FLAPPER**  
CHAIN: BEADED W/J-CLIP • CHAIN LENGTH: 12" • FLOAT

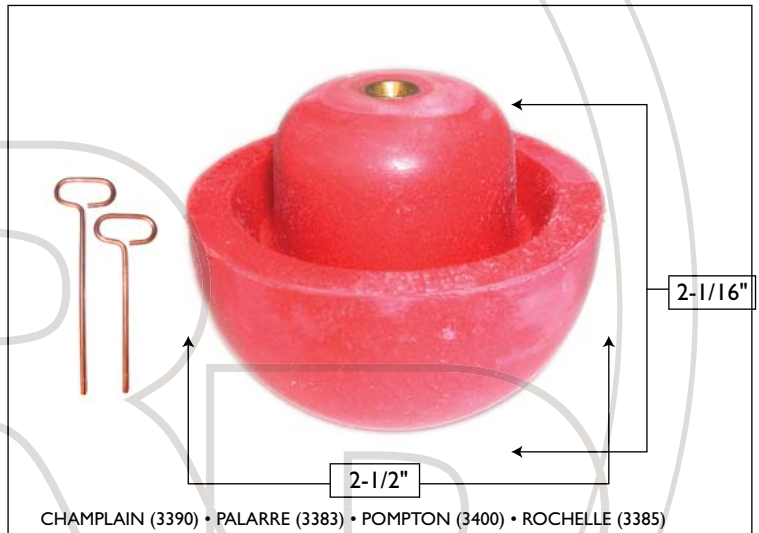

**KOHGP88921 • BALL**  
NEW STYLE BALL KIT WITH 2 LIFT RODS

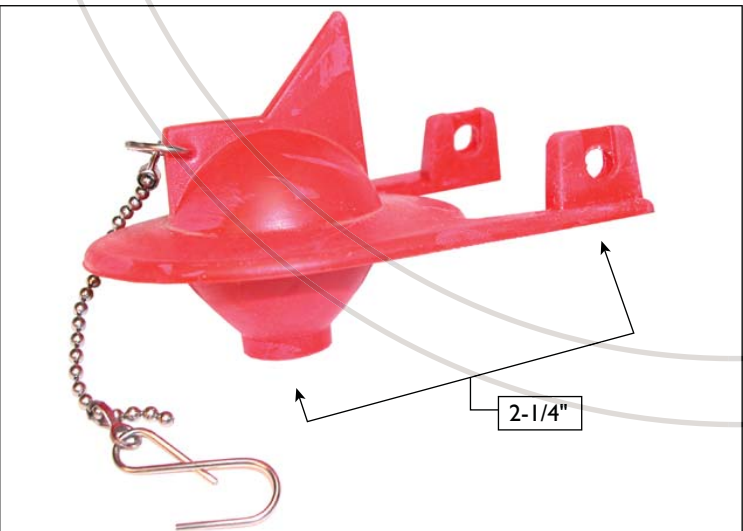

**KOHGP89825 • FLAPPER**  
CHAIN: BEADED W/J-CLIP • CHAIN LENGTH: 4-1/2"

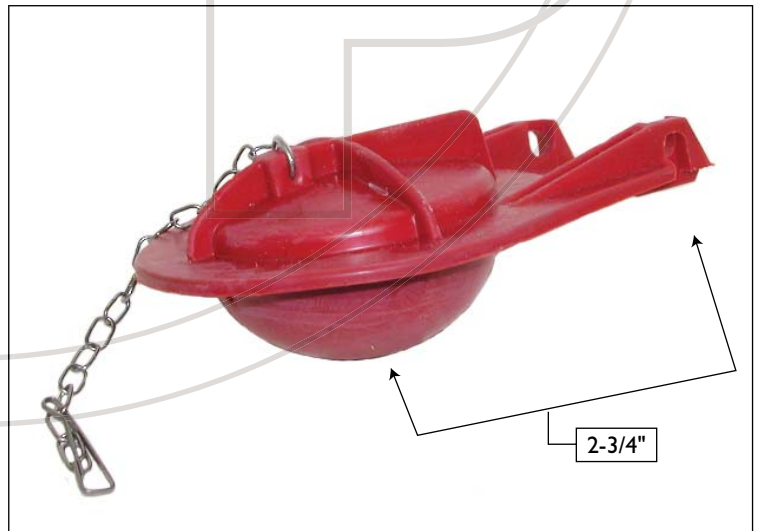

**KOHGP1039444 • FLAPPER**  
CHAIN: LINK W/CLIP • CHAIN LENGTH: 5"

# TOILET REPAIR PARTS • FLAPPERS & BALLS | KOHLER

CLASS FIVE™

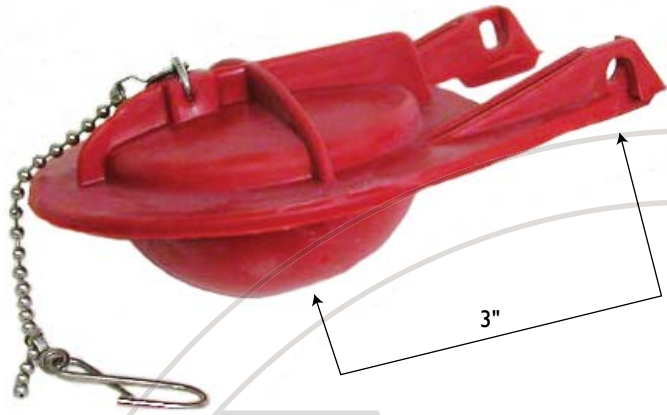

"Portrait" for 3506 tank

**KOHGP1060740 • FLAPPER**  
CHAIN: LINK W/J-CLIP • CHAIN LENGTH: 3-1/2"

CLASS FIVE™

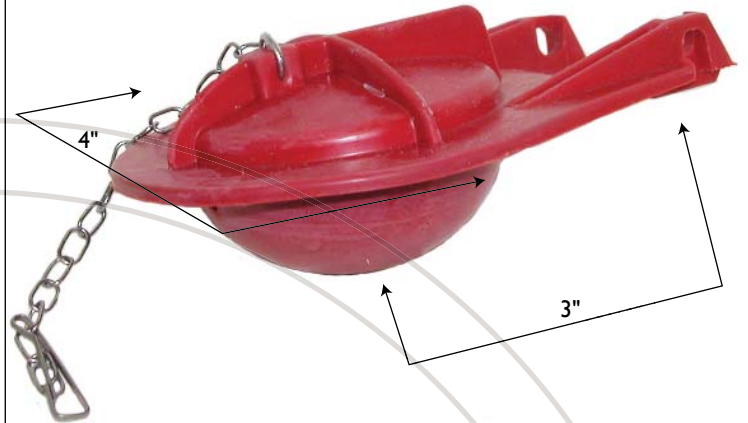

"Gabrielle" for 3513, 14344-S, 14345-WF, 14346-PD tanks

**KOHGP1067183 • FLAPPER**  
CHAIN: LINK W/CLIP • CHAIN LENGTH: 5"

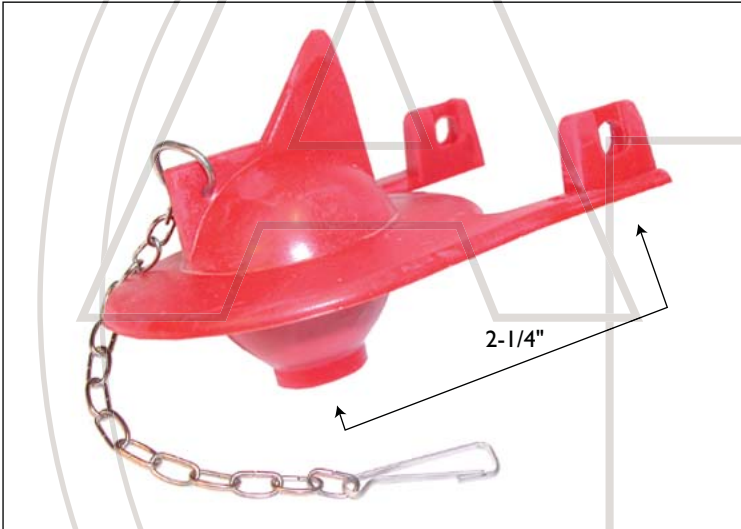

**KOHGP1078440 • FLAPPER**  
CHAIN: LINK W/CLIP • CHAIN LENGTH: 4" AND 5"



"Cadet" 1.6 (2798, 2898, 2998) for 4112 tank

**KOHGP1078441 • FLAPPER**  
CHAIN: LINK W/CLIP • CHAIN LENGTH: 7-1/2"

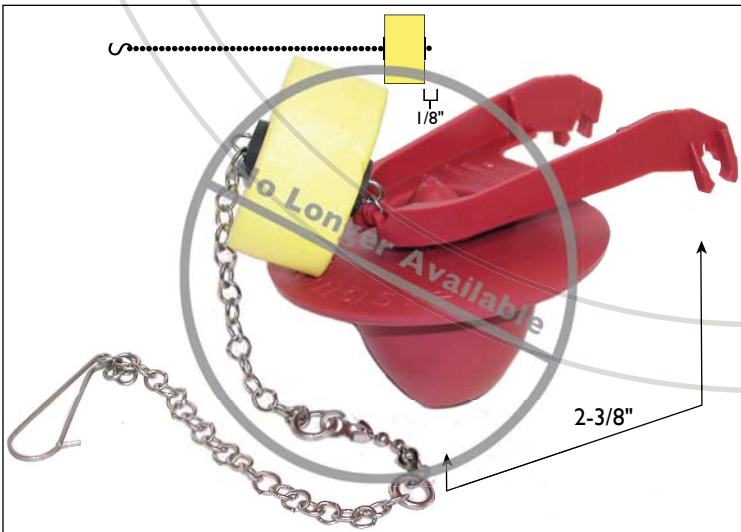

**KOHGP1079948 • FLAPPER**  
NLA USE KOHGP85160

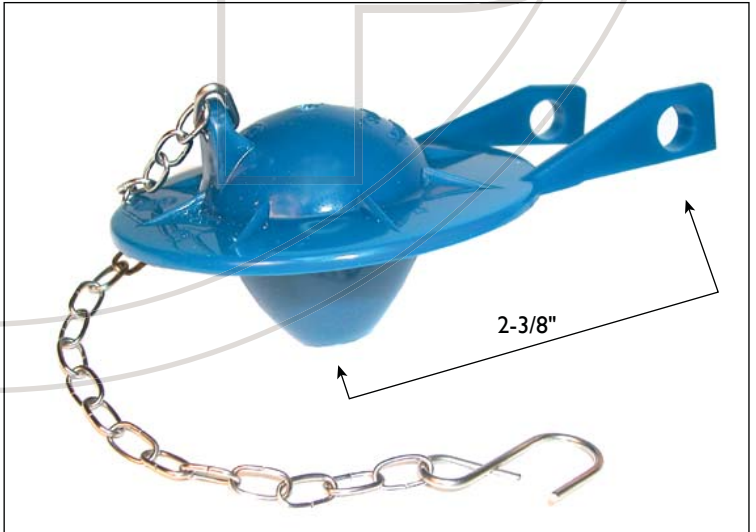

**KOHGP1079949 • FLAPPER**  
CHAIN: LINK W/J-CLIP • CHAIN LENGTH: 8"